

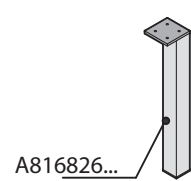

COLUMN

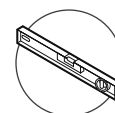
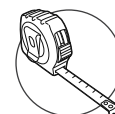
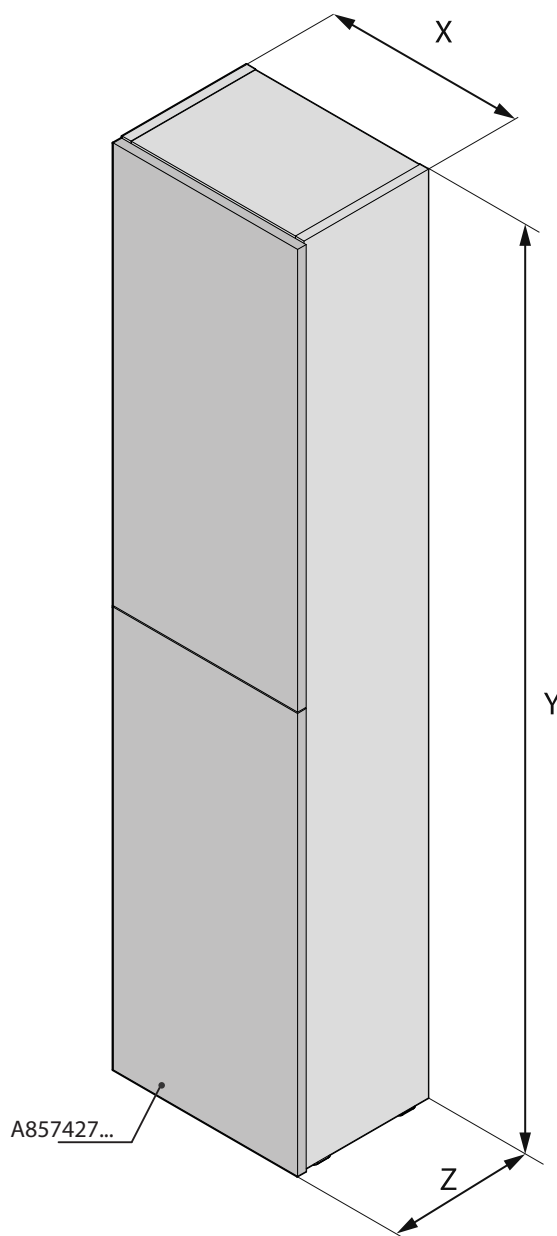

	mm		
	X	Y	Z
A857427...	345	1504	250

	mm		
	X	Y	Z
A816826...	35	335	35

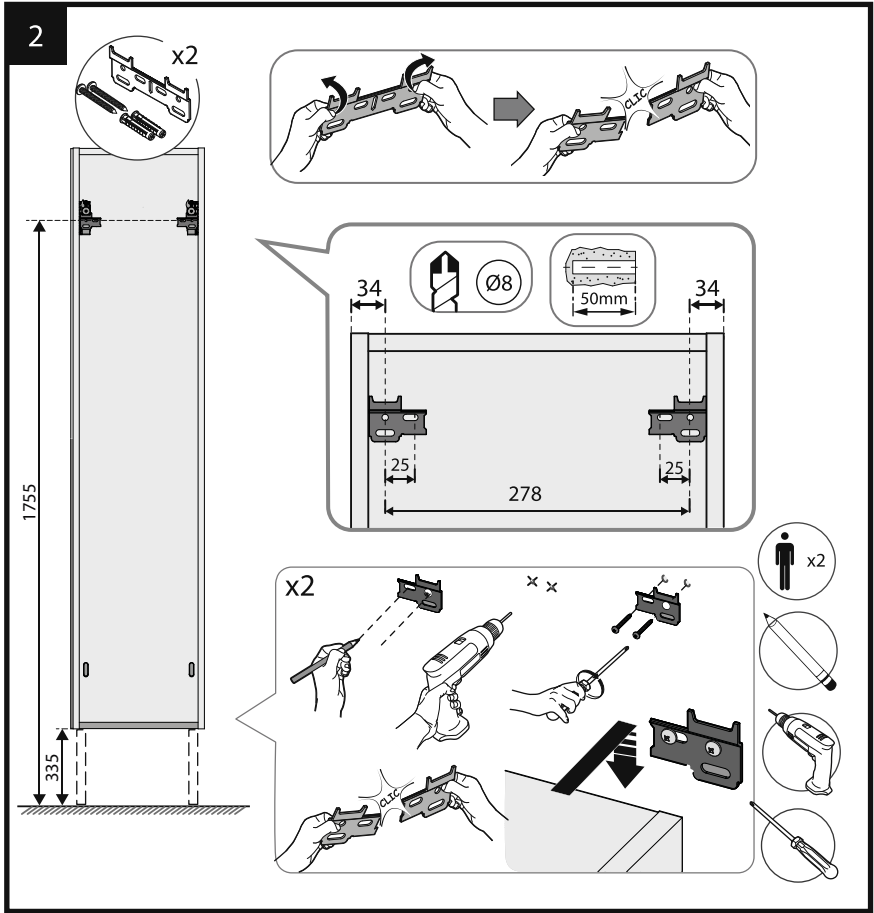
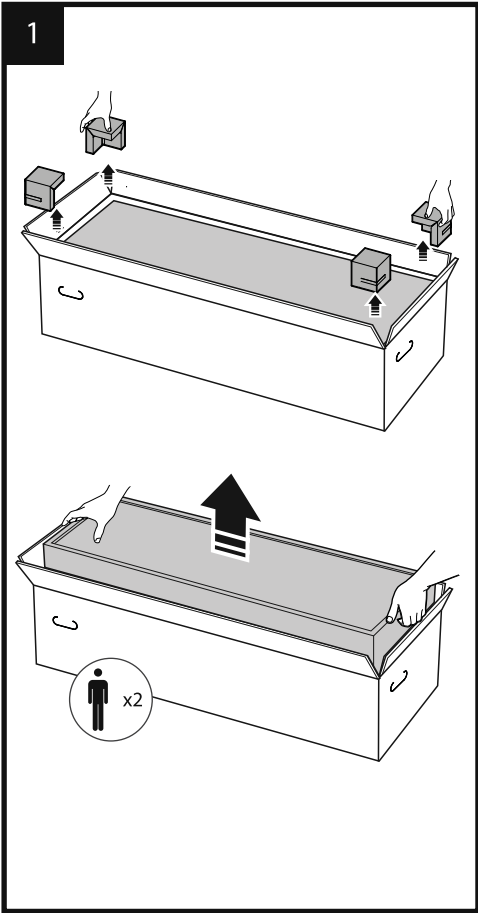

OPTIONAL

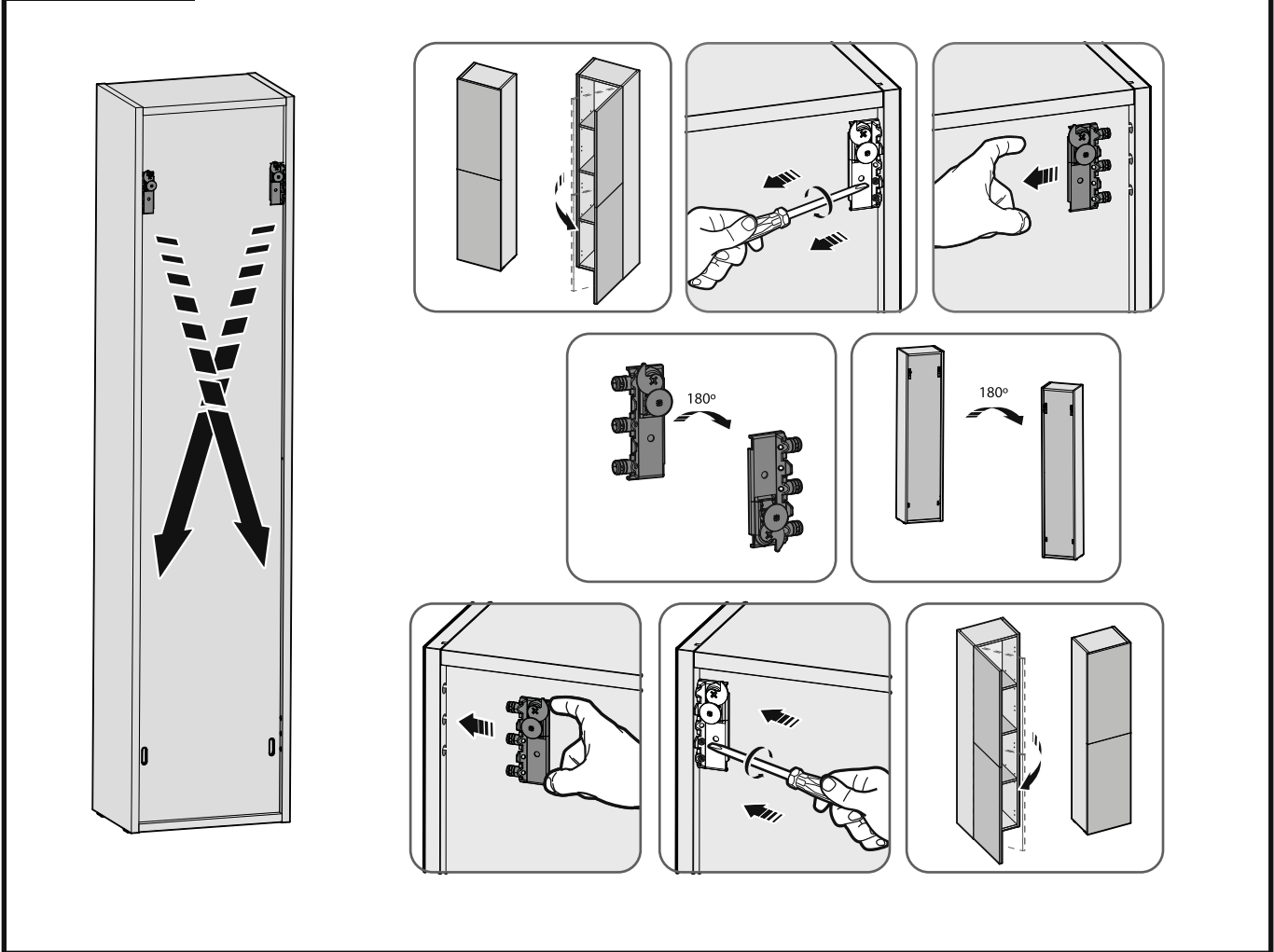

OPTIONAL

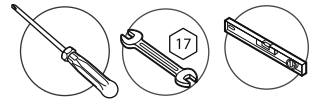
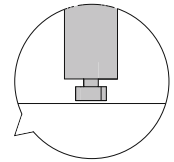
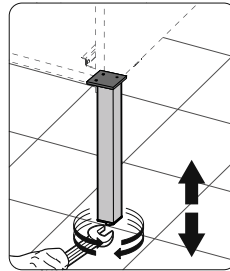
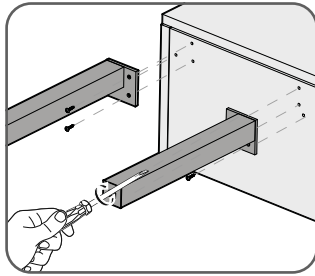
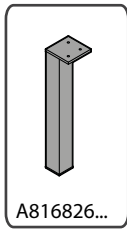
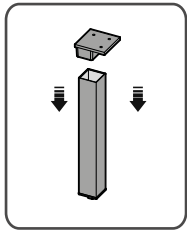

3

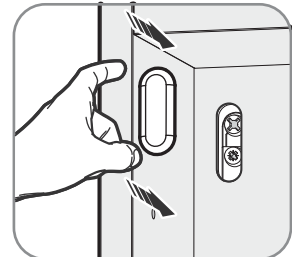
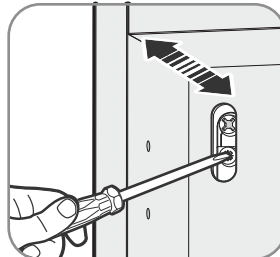
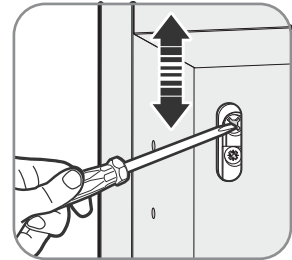
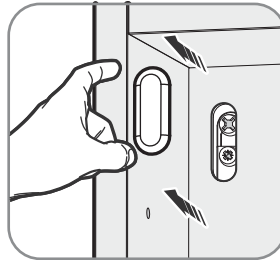
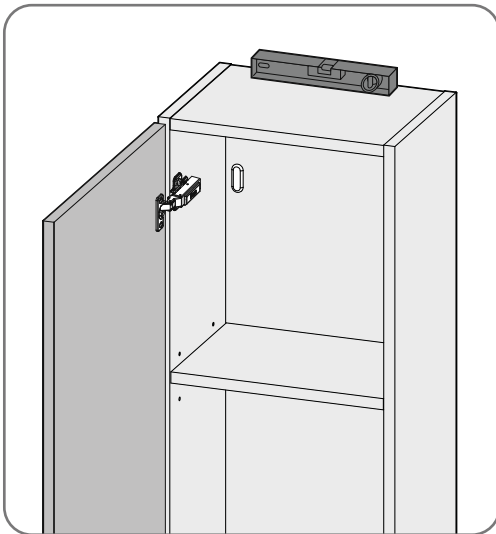

4

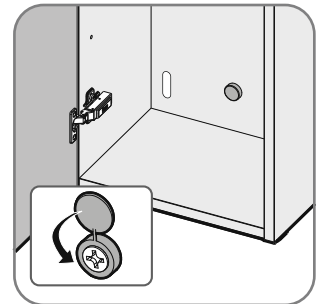
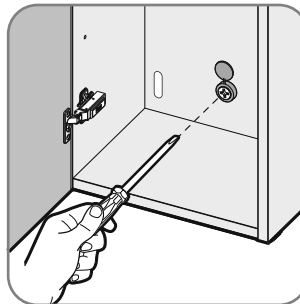
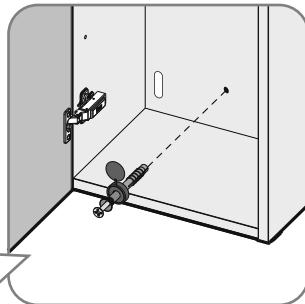
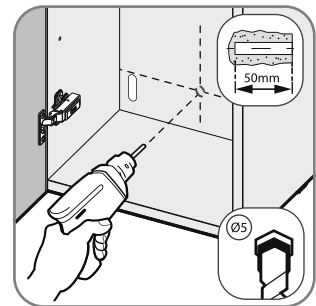
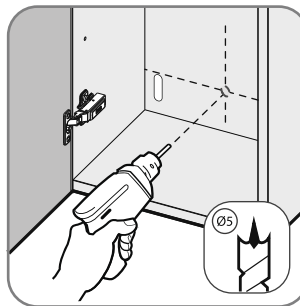
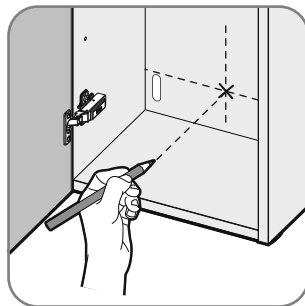
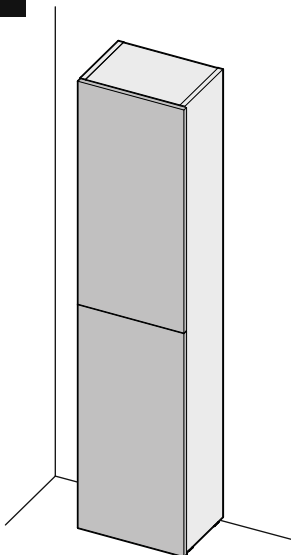

OPTIONAL

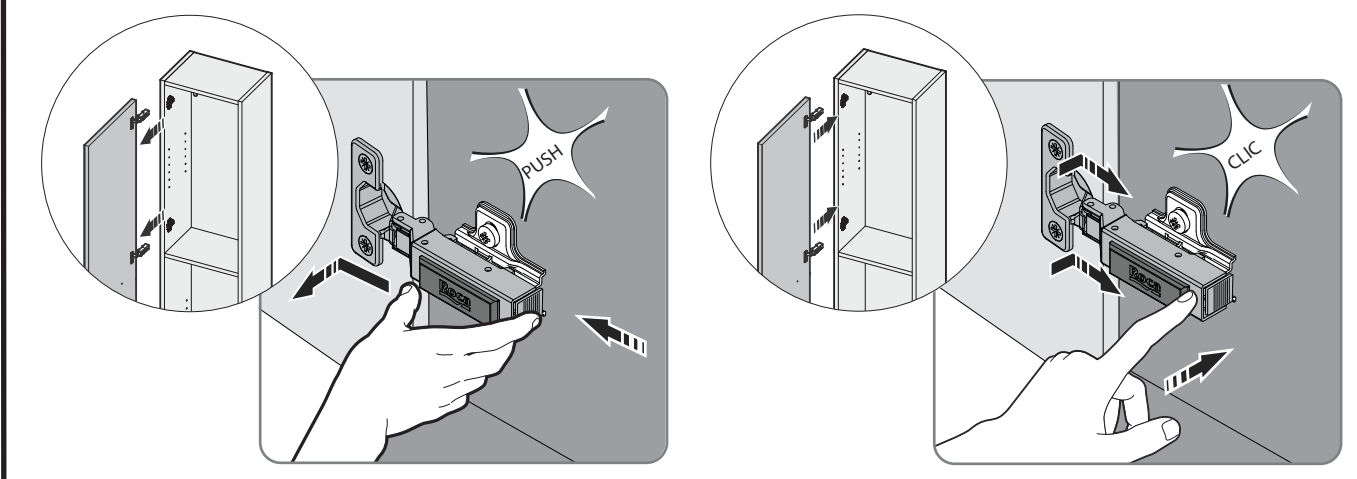

5

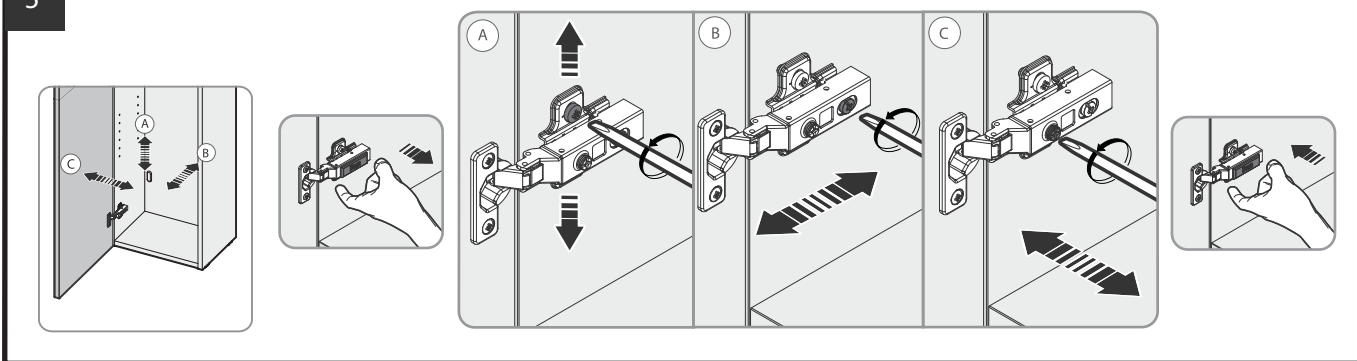

6

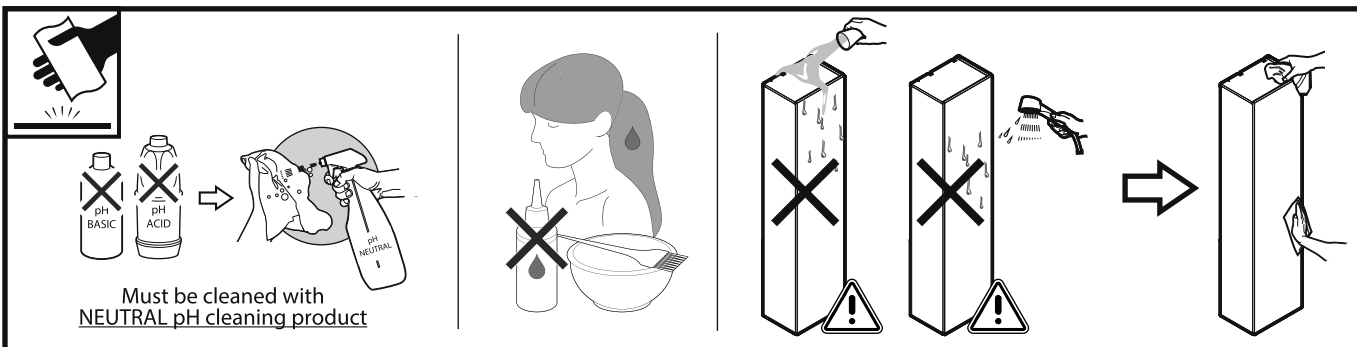
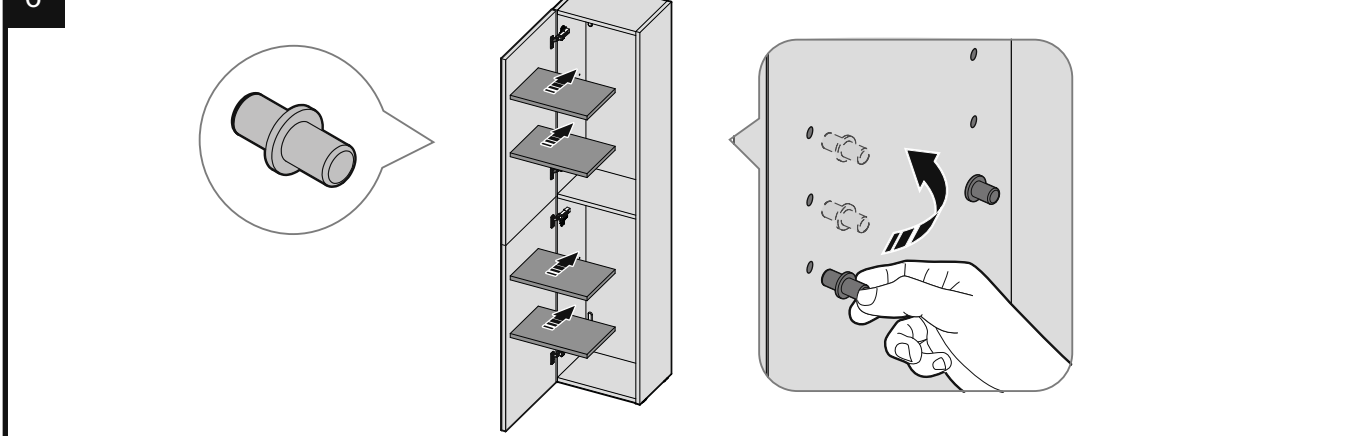

DIN A3

Q40600234G-e



Roca Sanitario, S.A.
Avda. Diagonal, 513
08029 Barcelona
SPAIN
www.roca.com

933 LÍNEA DE ATENCIÓN
661 AL CONSUMIDOR
266 ESPAÑA
SERVICIO TÉCNICO
ESPAÑA



productsupport.rs@roca.net
soporteproducto.rs@roca.net